



Planning *Guide*

ORIGINAL SERIES POOLS



Realize the Dream



Transforming your home for more convenient fitness and family fun is so much easier when you have the right partner! The team at Endless™ Pools has over 30 years' experience helping customers like you realize their dream of pool ownership. To start, we've developed this handy guide of project considerations, best practices, and customization options to make the process a cinch. So, let's get started!

To begin, let's discuss where your pool will be placed for optimal performance:

- A solid, level surface, such as a concrete pad
- A location that gives you access to at least one side (some option may require additional access requirements)
- A minimum 30-amp electric service, the same as for a clothes dryer. Select options will increase your power requirements.

Understanding the DNA of your new pool can help you choose the best installation method for you: are you handy enough for a DIY assembly, or will you contract the process out? You can hire a contractor of your choosing or use one of our Independent Service Providers (ISPs). All Endless Pools products arrive with comprehensive instructions; we also offer online video guides as well as live Customer Support during and after your assembly.

Do not leave pets unattended or unsupervised near Endless Pools products.

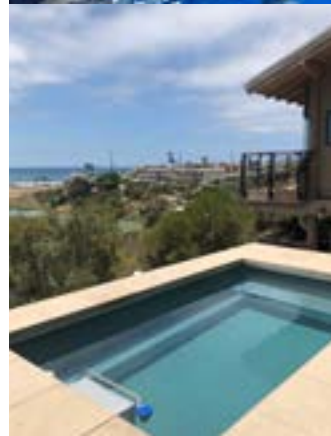

Your Pool Inside & Out

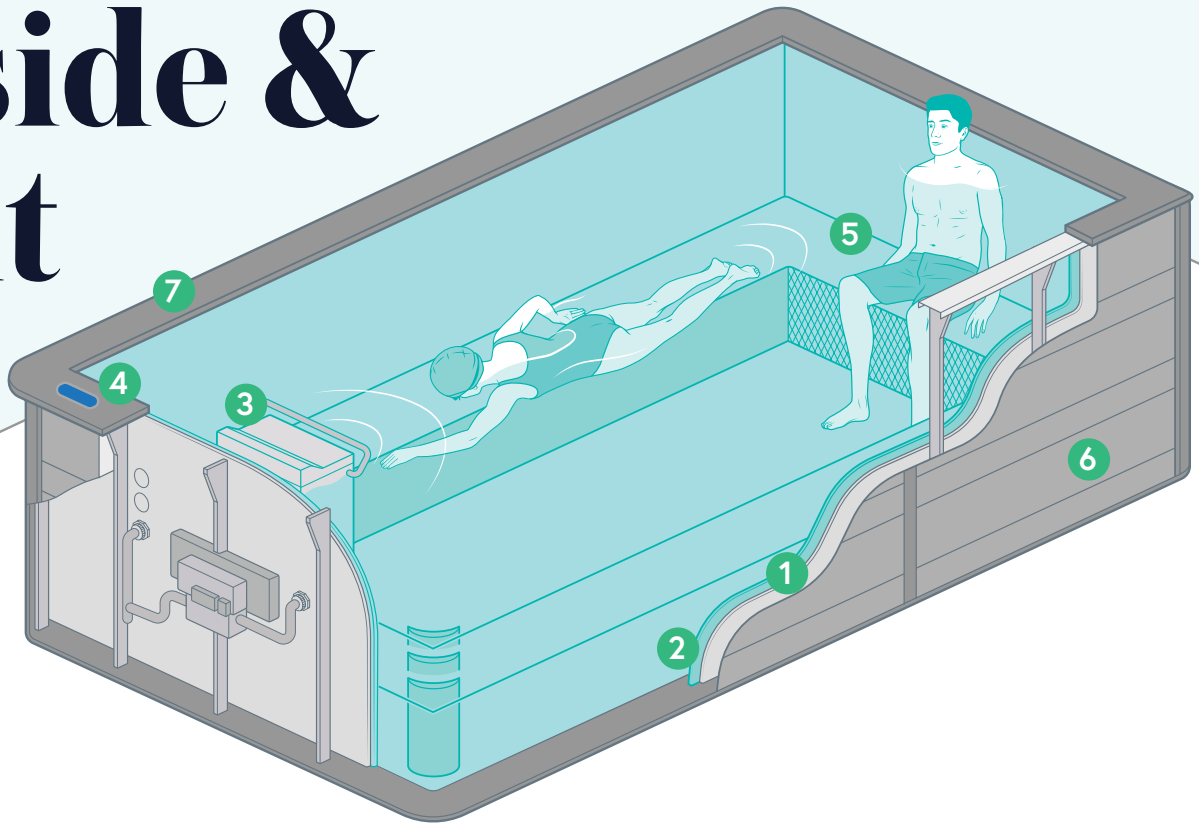

1. STEEL-PANEL WALLS

Sturdy and rust-resistant, our 14-gauge galvanized steel panels give you the flexibility to adjust your pool's size in one-foot increments. These panels come with a 10-year structural warranty.

VIDEO: [See how it's built!](#)

2. VINYL LINER

A vinyl liner gives you versatility, flexibility, and a beautiful interior. Our 28-mil. vinyl liner is 40% thicker than the 20-mil. liners standard in traditional in-ground pools. It allows you to customize your pool's size and appearance in a way that simply isn't feasible with fiberglass or acrylic spas. You can choose from a range of solids and patterns. Each fully replaceable liner comes with a 2-year warranty.

3. CURRENT SYSTEM

Inside this housing resides our exclusive technology to generate our signature current. Our propeller-generated current is spacious, smooth, and swimmable. Our space-saving technology utilizes built-in return channels to keep the water remarkably still on either side.

We offer multiple current options, including progressively faster top speeds for experienced swimmers, as well as larger and smoother currents that are friendlier for novice swimmers.

VIDEO: [See the current system in action!](#)

4. CONTROL PANEL

Your Endless™ Pools command center – from here, you can digitally control the water quality system, water temperature, and the optional lights and jets. For remote access, choose our optional Apple/Android controller.

5. RETURN CHANNELS

These channels return water from the rear of the pool to the current housing at the front and minimize turbulence in the process. In our 42" models, these channels also function as perimeter benches for seating.

6. SKIRTING

Choose our stylish, low-maintenance Ascent Skirting System with corner lighting or source your own locally. The skirting covers the steel panels as well as any insulation you add to conserve heat.

7. COPING

As with the skirting, you can choose our durable, attractive Apex Coping System for the perimeter ledge of your pool, or you can locally source your own.

The Fits-Almost-Anywhere Pool

On-site assembly means that you can set up your pool in a variety of locations, outside or indoors.

For cooler climates, you could enjoy an unprecedented year-round pool season at home! With a standard bathroom ventilation fan and nearby drainage, any ground-floor site can house your pool.

Every pool component can be walked through a standard door opening and down stairs, which makes this pool ideal for existing spaces, such as spare rooms, basements, and garages.

VIDEO: [Outdoor pool planning](#)

VIDEO: [Indoor pool planning](#)

Upper-floor and rooftop locations are possible with additional engineering. Our standard pool requires that the site be able to support between 262–337 lbs per square foot, depending on pool height. Ask your Product Specialist about an Endless™ Pools engineering consultation, available at no extra cost.

YOU DECIDE,

Indoors or Outside, (1) [Backyard](#), (2) [Deck](#), (3) [Basement](#), (4) [Garage](#) or (5) [Sunroom](#), the Endless Pools Original Series Pools fit just about anywhere!

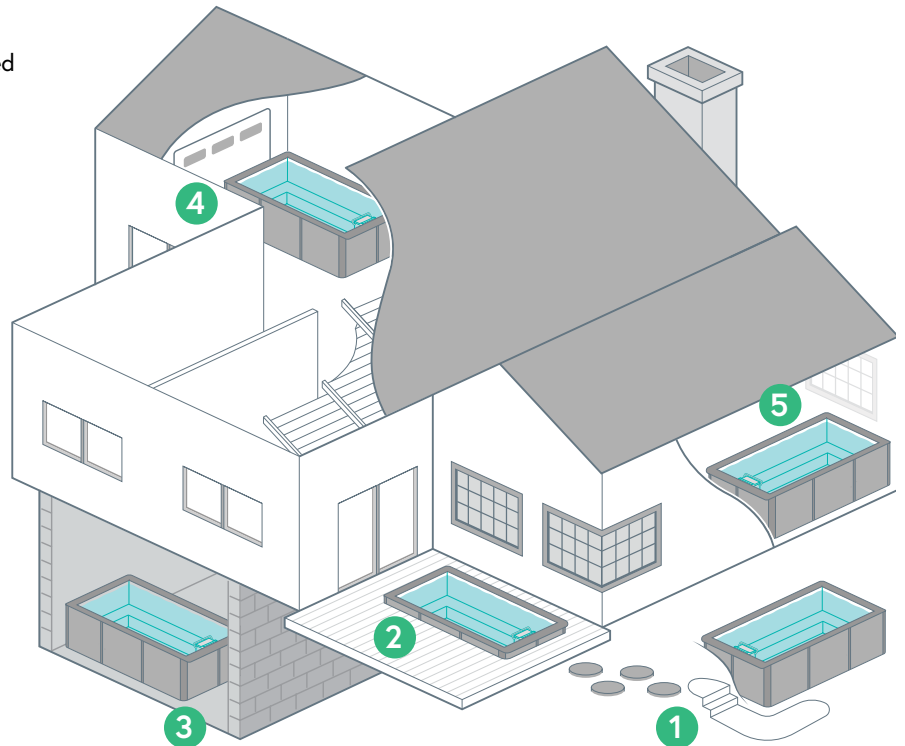

Get the Best Installation Price

Reliability and peace of mind – that's what you get with an experienced Endless Pools Independent Service Provider (ISP).

You can use any contractor to assemble your pool. You may even choose to do it yourself. For the most experienced pool assembly at a guaranteed price, ask your Product Specialist for a referral to an Independent Service Provider in your area.

[Money-saving Guaranteed Assembly Program.](#)

HOW TO CONTROL YOUR COSTS

- Select an existing site.
- Install above-ground.
- Choose our affordable skirting/coping.
- Properly insulate your pool.
- Choose to install the pool yourself or select a Independent Service Provider.

[Learn more about controlling pool costs](#)



Finishing Options

Every Original Series pool gives you complete versatility to match the exterior look and design to your home's aesthetic.

OUR MATERIALS

Endless™ Pools offers two styles for skirting (the vertical walls that surround your pool's exterior) and coping (the perimeter ledge at the top of the pool).

Our Ascent Skirting System includes corner lighting and is designed for easy installation. Its durable, stylish laminate mimics the look of real wood without the maintenance hassles.

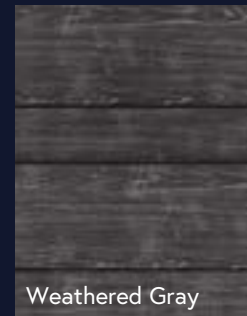

Weathered Gray

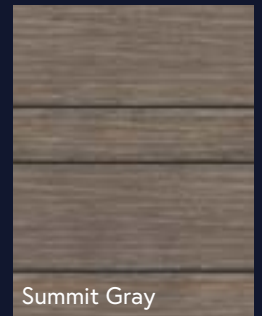

Summit Gray



Choose our Apex Coping System for the easiest installation. Our coping is UV stabilized to prevent cracking and color loss in any environment. It features gracefully rounded corners for a clean, modern finish.



Desert Plateau

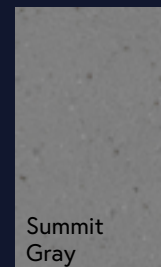

Summit Gray



Artic Ice

YOUR MATERIALS

Some customers choose to source their own skirting and coping.

Our pools have been skirted in everything from stacked stone to stone veneer, from moisture-resistant cedar shingles to reclaimed oak planks, from imported marble to faux-marbled wood panels.

Choose your own coping in any durable, water-resistant material. If you prefer a wood finish, ask about our receiver system for the easiest, most secure installation. For fully in-ground pools, we offer a coping option to provide a finished edge to abut your decking. Contact your product specialist for any special needs specific to your sourced finishing material.



Site Planning

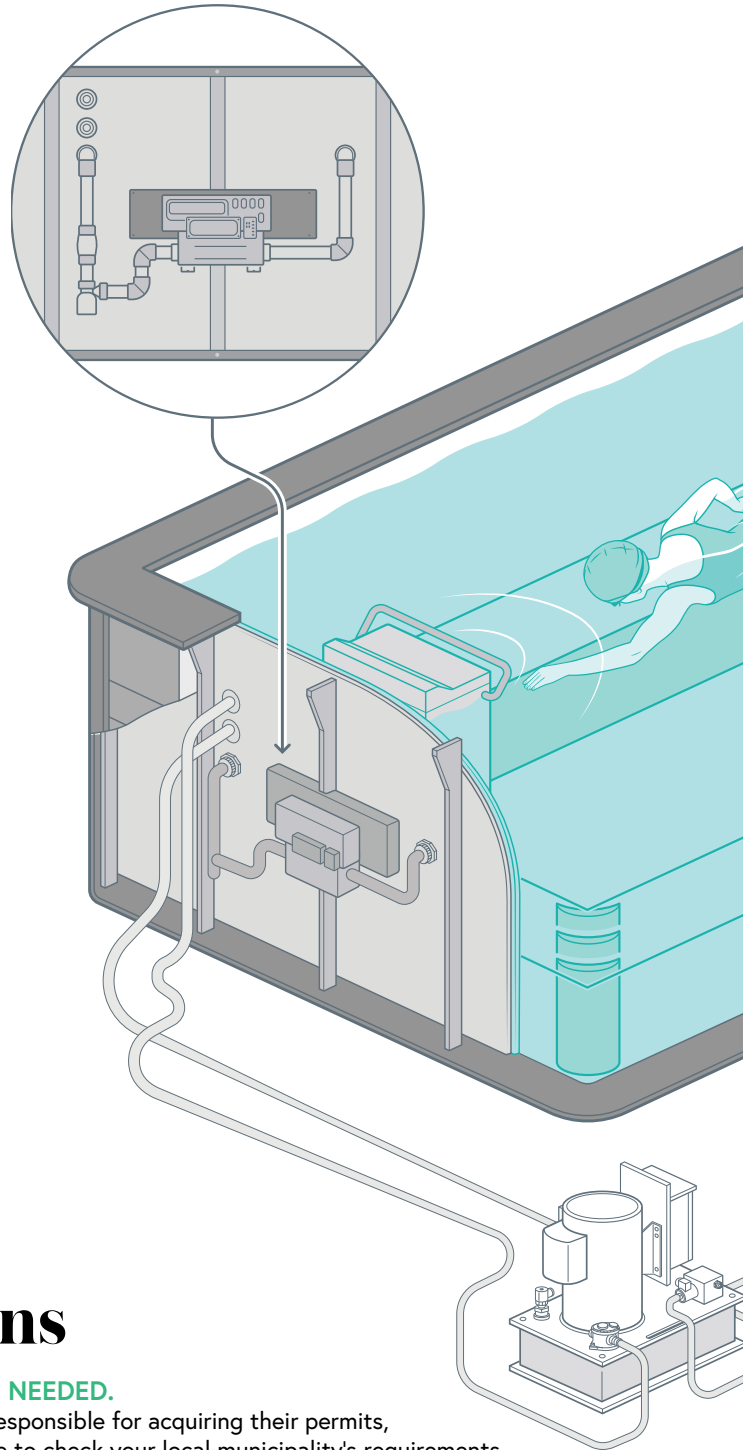

1. FRONT OF POOL

- Heating, filtration, and water quality equipment
- Pump for optional hydrotherapy jets
- Controlled by keypad up to 10 feet away

2. EQUIPMENT ACCESS

- Pool front cannot be placed against a wall
- For select options, additional clearance(s) may be required
- In-ground installations only: must have an accessible pit; sump pump recommended

3. POOL FOOTPRINT

Be sure to include your coping when determining your pool's outside dimensions. If you choose our Apex Coping System, allow as follows:

- Sides and rear: 10-3/4 inches
- Front: 21-1/8 inches
- Front (with Poolside Hydraulic Power Unit): 27-3/4 inches

4. REMOTE EQUIPMENT

- 5-hp Hydraulic Power Unit (usually located near your electric service)
- Minimum electrical requirement: single 30-amp, 220-volt, GFCI service with shutoff supplied by the customer in accordance with local code
- Connected to pool by flexible 2" PVC conduit and hoses for hydraulic fluid (25 feet standard, optional up to 75 feet)

Site Preparation Tips

Pre-Delivery Considerations

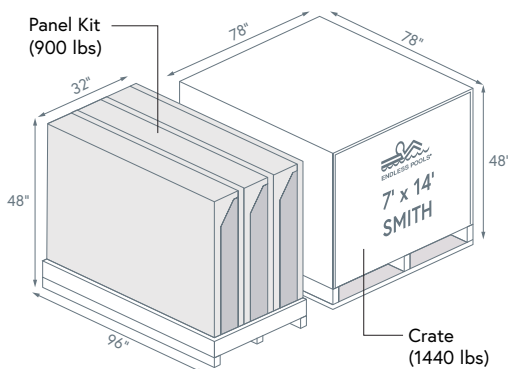

ENDLESS™ POOLS ORIGINAL MODEL SHIPMENT SAMPLE

Sidewall Reinforcing Channels
(Not pictures): 136" x 7" x 6" (100 lbs)

GET A PERMIT... IF NEEDED.

Each homeowner is responsible for acquiring their permits, when needed. Be sure to check your local municipality's requirements. Defining your pool as an "Exercise Spa" rather than a permanent pool has significant permit ramifications in many municipalities.

CHOOSE AN INSTALLER.

You may choose an independent Independent Service Provider for experienced assembly at a guaranteed price or engage your own favorite general contractor. Some customers even choose a DIY installation. Regardless, you will have unlimited phone/email access to our Customer Service team for the life of your pool.

VIDEO: [DIY installation](#)

PREPARE FOR DELIVERY.

Our Shipping Representative will contact you with complete details once your pool is in transit from our Pennsylvania headquarters. Once your pool arrives, the driver will place the crate and panel skid on the first accessible flat surface.

*Dimensions and weight will vary based on your product configuration.

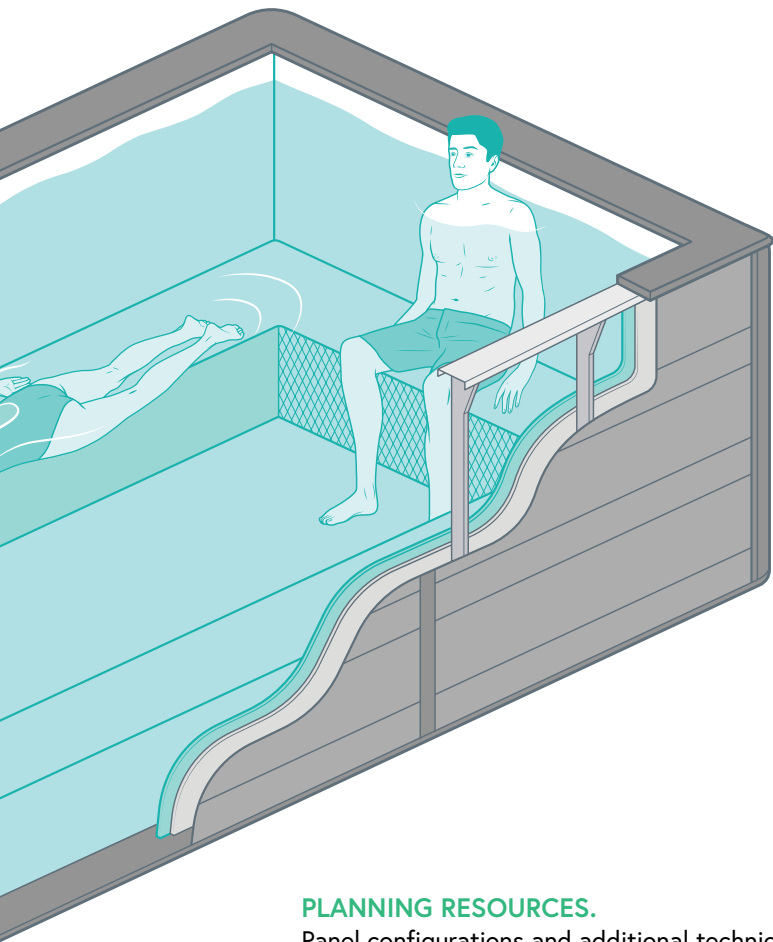

PLANNING RESOURCES.

Panel configurations and additional technical drawings are available upon request. Please speak with your Product Specialist for more information.

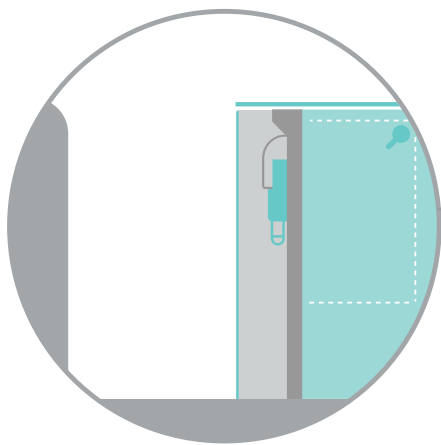
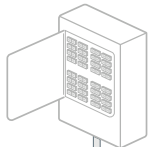

FULLY IN-GROUND EQUIPMENT ACCESS.

Remember that access is required to the front panel for equipment maintenance. If you plan to excavate and sink the pool in-ground, construct a pit that is 3' out from the front panel. Some options may require additional access requirements.

Depth and Accessibility

Before finalizing your pool's location and height, consider how you will access the pool. Endless™ Pools offers many options, as well as our design flexibility, to make your pool accessible to all.

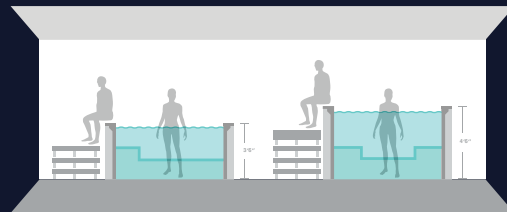

ABOVE-GROUND

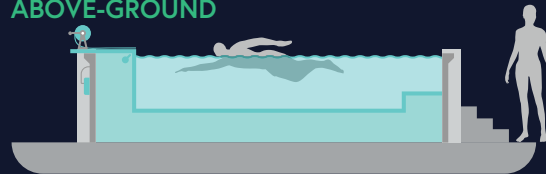

- Your easiest and most cost-effective option
- Access provided by exterior stairs with users entering the pool from a seated position.
- Handrails and grab bars also available

PARTIALLY IN-GROUND

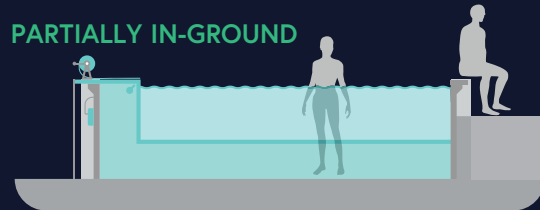

- The easiest to access for all
- Created with excavation or by constructing decking to the desired height
- Pool coping serves as stable seating which allows users to enter from a sitting position
- Interior corner steps and risers available to install on the rear return channel

FULLY IN-GROUND

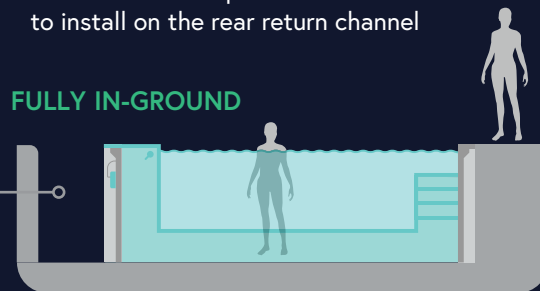

- The most elegant, low-profile option
- Created with excavation or by constructing decking to the coping
- Taller coping rails are available to assist entry and exit
- Interior corner steps and, for deeper models, risers available to install on the rear return channel. Users generally enter the pool from a standing position.



Endless Pools • 1601 Dutton Mill Road • Aston, PA 19014-2931
www.endlesspools.com • swim@endlesspools.com
800-7732-8660 • 610-686-7252

©2024 Wellness Marketing Corporation
D49002 0425